

UBIBOT

# Smart Network Relay NR1

User Manual

**DIREKTRONIK**

This user manual serves as a general guidance for all types of UBIBOT® Smart Network Relay. Some features, which are marked with asterisk, are available only for specific versions. Please refer to related instructions according to the version you purchased.

## PACKAGE LIST

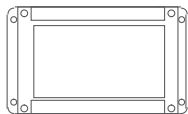

① Device

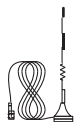

② External antenna



③ Adapter

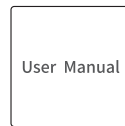

④ User manual

Note: Please tighten the antenna before use.

## INTRODUCTION

### 1. Basic Features Introduction

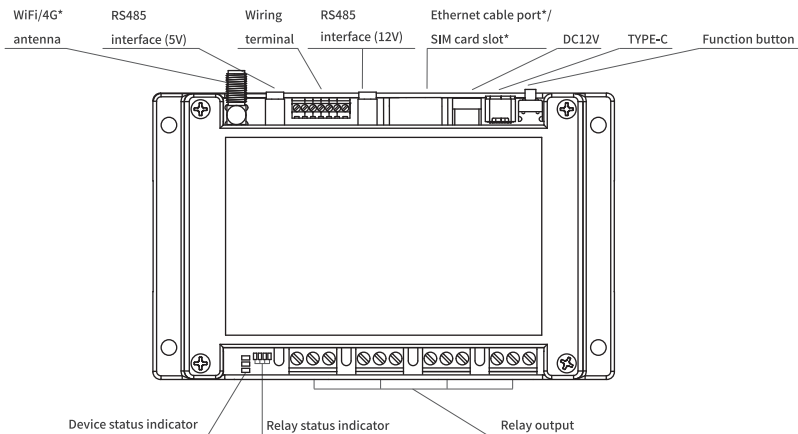

## 2. Device Operations

### Switch On/Off

After the power is plugged in/unplugged, the device will Switch On/Off automatically.

### Setup Mode

With the device switched on, press and hold the function button for about 5 seconds until the device status indicator flashes red and green alternately. Release at this time to enter the setup mode.

### Send data

Under power-on state, press the function button once, the green device status indicator will flash, then connect to the network and send data.

### Reset to Default Settings

Under power-on state, press and hold the function button for about 15 seconds until the red device status indicator blinks, then release the button to restore factory settings.

## Electrical Wiring

### 1. Interface

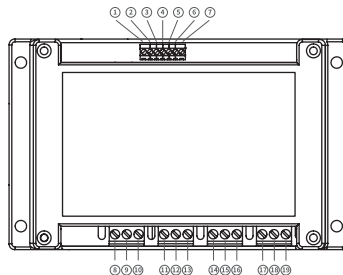

- |                       |                       |
|-----------------------|-----------------------|
| ① COM-                | ⑪ NO node of Relay 2  |
| ② Digital Input 1     | ⑫ COM node of Relay 2 |
| ③ Digital Input 2     | ⑬ NC node of Relay 2  |
| ④ Digital Input 3     | ⑭ NO node of Relay 3  |
| ⑤ Digital Input 4     | ⑮ COM node of Relay 3 |
| ⑥ COM+                | ⑯ NC node of Relay 3  |
| ⑦ Output of DC 12V    | ⑰ NO node of Relay 4  |
| ⑧ NO node of Relay 1  | ⑱ COM node of Relay 4 |
| ⑨ COM node of Relay 1 | ⑲ NC node of Relay 4  |
| ⑩ NC node of Relay 1  |                       |

## 2. Device Operations

① Passive switch (dry contact): passive contact signal, with two states (off/on), no polarity between the two contacts, such as various types of switches, buttons, etc.

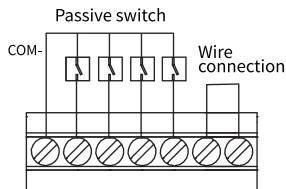

② Active switches (wet contact, DC5-12V): signals with voltage (high/low level, pulse), with two states (power/no power), polarity between the two contacts, such as liquid level detection, smoke detection, PLC output, infrared detection, flow detection, etc.

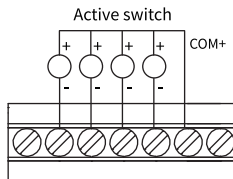

## 3. Relay Output Wiring

① Low load wiring: Non-resistive load current less than 3A or resistive load less than 5A.

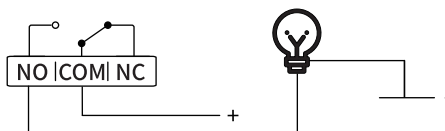

② AC 220V load wiring: external load is AC 220V power supply.

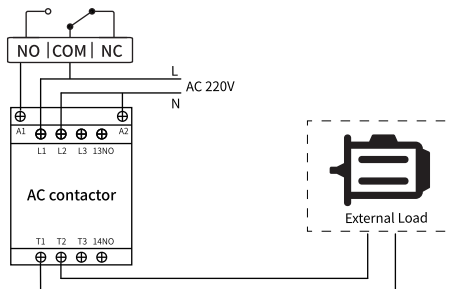

③ AC 380V (with null line) Load wiring: The external load is AC 380V with null line.

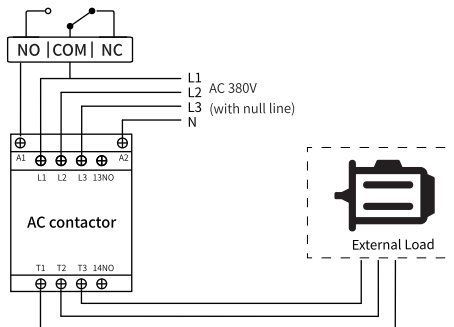

⚠ If necessary, insert an AC contactor/intermediate relay between the product and the external load.

① Rated load voltage > DC 30V

③ Non-resistive load current > 3A

② Load rated voltage > AC 250V

④ Resistive load current > 5A

## DEVICE SETUP OPTIONS

### Option 1: Using Mobile App

Download the App from [www.ubibot.com/setup](http://www.ubibot.com/setup), or search for 'Ubibot' on the AppStore or Google Play.



We recommend you try to use the PC Tools in case the App setup fails, because the failure may be due to mobile phone incompatibility. The PC Tools is much easier to operate and suitable for both Mac and Windows.

### Option 2: Using PC Tools

Download the tool from [www.ubibot.com/setup](http://www.ubibot.com/setup).

This tool is a desktop app for device setup. It is also helpful in checking setup failure reasons, MAC address, and offline charts. You can also use it to export offline data stored in the device internal memory.

## SETUP USING THE APP FOR WiFi CONNECTION

Launch the App and log in. On the home page, tap "+" to start adding your device. Then please follow the in-app instructions to complete the setup. You can also view the demonstration video at [www.ubibot.com/-setup](http://www.ubibot.com/-setup) for step by step guidance.

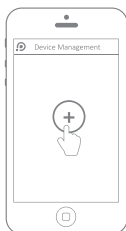

[Add your device](#)



[Scan the QR code](#)

Via our app and web console (<http://console.ubibot.com>), you are able to view the readings as well as configure your device, such as create alert rules, set data sync interval, etc. You can find and watch the demonstration videos at [www.ubibot.com/setup](http://www.ubibot.com/setup).

## SETUP USING THE APP FOR MOBILE NETWORK\*

Before you set up the device on mobile data, please check the APN information of the SIM card used for the UbiBot device.

An APN (Access Point Name) provides the details your device needs to connect to mobile data through your network operator. APN details differ by network and you will need to get these from your network operator.

With the device off, insert the SIM card as indicated in the picture. Launch the app and log in. Tap the "+" to start set up the device. Please follow the in-app instructions to complete the setup process. Please note, the setup will fail if you don't have data allowance.

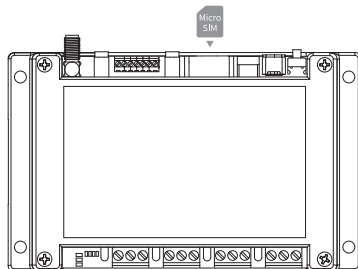

## SETUP USING THE APP FOR ETHERNET CABLE CONNECTION\*

**STEP 1.** Connect the device with power supply and plug the Ethernet cable.

**STEP 2.** Launch the app and log in. On the home page, tap "+" to start adding your device. Then please follow the in-app instructions to complete the setup. You can also view the demonstration video at [www.ubibot.com/setup](http://www.ubibot.com/setup) for step by step guidance.

## SETUP USING PC TOOLS

- STEP 1.** Launch the App and log in. With the device switched on, use the Type-C USB cable provided to connect your device to the computer. The PC Tools will automatically scan and recognize the product ID and enter the device page.
- STEP 2.** Click "Network" on the left menu bar. There, you are able to set up the device on WiFi for all the models. For the SIM or Ethernet cable setup, please click on the corresponding button to continue.

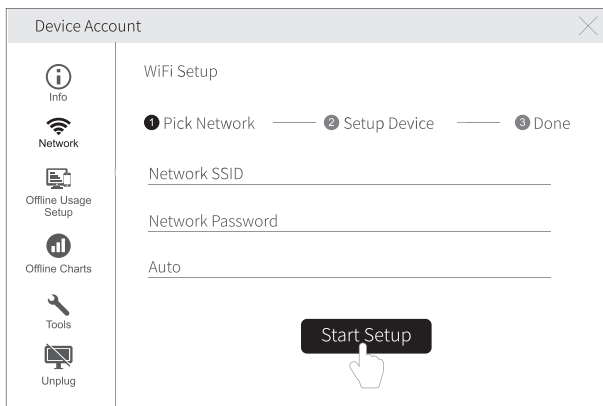

## RS485 COMMUNICATION

The default mode is the RS485 communication slave mode. If the external sensor collection time is set in the platform, the master mode for data collection will be activated and the slave mode will be turned off automatically. If the device has been networked, the setting parameters are set by the platform.

For more details, please contact your local distributor or refer to the online documentation.



# DEVICE USE

## 1.Working Mode

- ① **Online control mode:** you can remotely control relay operations through the UbiBot cloud platform, including opening/closing the relay, the overall synchronization or independent single-point control, timing and cycle setup, delaying tasks or defining trigger conditions through early warning rules and automation control.
- ② **Pules on/off mode:** Pulse ON, i.e., when the relay is in closed state, the relay can be set to disconnect for a period of time (set parameter\*0.1s) and then close automatically. Pulse OFF, i.e., when the relay is in disconnected state, the relay can be set to close for a period of time (set parameter\*0.1s) and then disconnect automatically.
- ③ **Local linkage mode:** The device has 4 optocoupler inputs, which can be directly linked with the relay. It means that when the optocoupler input signal is effective, the corresponding relay will absorb/disconnect/no action; when the optocoupler input signal is canceled, the corresponding relay will disconnect/absorb/no action. The corresponding relationship between the optocoupler input and the relay's absorption/disconnection/non-activation can be set through the PC tools or the UbiBot platform.
- ④ **Offline control mode:** The NR1 device supports the Modbus RTU protocol, allowing for offline control of 4-channel relays through an RS485 connection to a computer.
- ⑤ **Safety interlock mode:** The device supports safety interlock setting. if any of the relays set for safety interlocking is turned on, the other relays will be turned off.

## DEVICE SPECIFICATION

 Power contact capacity 250V AC/10A, 30V DC/10A

 Each relay can switch 100,000 times

 4-way DI input (optocoupler isolated)

 WiFi band 2.4GHz, channel 1-13

 1 x Type-C, 1x terminal block, 4 x relay outputs, 1 x power connector, 2 x RS485 interface

 12V DC/2A

 145mm x 90mm x 40mm

-  Built-in memory chip can cache 300,000 pieces of data

---

-  Some versions of the device support mobile network communication, network parameters are subject to the purchase of specific products and features.

---

-  Some versions of the device support Ethernet network communication, subject to the purchase of specific products and features.

---

-  15mm x 12mm x 0.8mm (standard medium card) size SIM card (optional)

---

- ① Device operating environment: temperature range -20 to 60 °C; humidity range 5 to 85%.

---

## FAQ

### 1. Device network configuration failure reasons

- ① Please check if the WiFi account password is correct;
- ② Please check whether the router is working properly and the network connection is normal;
- ③ Please make sure the device has entered the WiFi configuration mode;
- ④ Please check whether the WiFi band is 2.4GHz and the channel is between 1~13;
- ⑤ Please check the WiFi channel width is set to 20MHz or auto mode;
- ⑥ WiFi security type: NR1 supports OPEN, WEP and WPA/WPA2-personal;
- ⑦ Poor signal strength, please check the WiFi or cell phone data traffic signal strength.

### 2. Ethernet network\* configuration failure reasons

- ① Please check whether the network cable is properly connected to the equipment;
- ② whether the network cable is intact;
- ③ whether the connected network can access the Internet;

If the above points are not abnormal, and you still cannot activate the device, you need to check whether the network environment allows DHCP (automatic IP allocation) devices to access the network; or re-scan the device QR code, select Ethernet access (advanced mode), and follow the APP prompts to manually assign IP to the device.

### 3. Reasons for failure to send device data

- ① Check whether the router is working properly;
- ② If using the mobile data traffic provided by the SIM card\* inside the device, you need to check whether the SIM card\* is activated; if the SIM card\* is activated, check whether the power supply of the device is normal; also check whether the amount of the mobile data traffic provided by the device SIM card\* is sufficient for the data transfer.

### 4. Can the device be used in a network-free environment?

The device can still work without network, and can be controlled in real time through the switch input or RS485 interface.





For more frequently asked questions, please visit [www.ubibot.com](http://www.ubibot.com) and go to the "Community and Documentation" page.

## TECHNICAL SUPPORT

The UbiBot team is glad to hear your voice of our products and services.

For any questions or suggestions, please feel free to create a ticket in the UbiBot app. Our customer services representatives respond within 24 hours and often in less than an hour. You can also contact the local distributors in your country for localized service. Please go to our website to view their contacts.

## PRODUCT MAINTENANCE INSTRUCTIONS

-  Please always follow the instructions contained in this manual.
-  Always mount the device on a stable surface.
-  Keep away from acidic, oxidising, flammable or explosive substances.
-  When handling the device, avoid using excessive force and never use sharp instruments to try and open it.

## WARRANTY INFORMATION

1. The warranty period for this product is one year from the date of purchase. The buyer is required to submit a valid proof of purchase. During the warranty period, free repair will be provided for any failure caused by the quality of the product under normal use. The mailing cost of the returned product is the responsibility of the sender (one way).

### 2. The following cases are not covered by the warranty:

- ① the product is out of warranty;
- ② product failure or damage caused by incorrect or improper operation not in accordance with the product use instructions, configuration instructions, and product maintenance instructions;
- ③ accidental or man-made damage to the product, such as exceeding the temperature and humidity range of the equipment, water-caused damage, including natural water, such as water vapor, etc., fall, abnormal physical force, deformation, cable breakage, etc.;
- ④ damage due to natural wear and tear, consumption and aging, etc. (including shells, cables, etc.);
- ⑤ failure or damage caused by unauthorized dismantling of the product without permission;
- ⑥ failure or damage caused by force majeure, such as earthquake, fire, lightning strike, tsunami, etc.;
- ⑦ other failure or damage caused unrelated to product design, technology, manufacturing or quality.

**DIREKTRONIK**

V1.0.0