

DIREKTRONIK

DMM9000BT

User Manual / MANUAL DEL USUARIO /
Manuel d'utilisation / Benutzerhandbuch /
Manuale Utente



UK
CA

CE



3
YEARS
LIMITED
WARRANTY

- EN High-Performance True-RMS Industrial Logging Multimeter
- ES Multímetro de registro industrial de RMS real de alto rendimiento
- FR Multimètre d'enregistrement industriel TRMS haute performance
- DE Leistungsstarkes True-RMS-Industriemultimeter
- IT Multimetro Industriale a Registrazione Vero RMS a Prestazioni Elevate

Safety Information

Understand and follow operating instructions carefully. Use the meter only as specified in this manual; otherwise, the protection provided by the meter may be impaired.

WARNING

This identifies hazardous conditions and actions that could cause BODILY HARM or DEATH. To avoid possible danger, follow below guidelines.

- Use the meter only as specified in this manual or the protection by the meter might be impaired.
- Never operate the meter with the cover removed or the case open.
- To avoid false readings that can lead to electric shock and injury, replace battery as soon as low battery indicator.
- Use caution with voltages above 30VAC rms, 42VAC peak, or ± 30 VDC. These voltages pose a shock hazard.
- When using test leads or probes, keep your fingers behind the finger guards.
- Remove test lead from meter before opening the battery door or meter case.
- Always use proper terminals, switch position, and range for measurements.
- Do not apply more than the rated voltage, as marked on meter, between terminals or between any terminal and earth ground.
- Do not use the High Frequency Rejection (Low Pass Filter) option to verify the presence of hazardous voltages. Voltages greater than what is indicated may be present. First, make a voltage measurement without the filter to detect the possible presence of hazardous voltage. Then select the filter function.
- To avoid possible electric shock or personal injury, never attempt an in-circuit current measurement where the open circuit potential to earth is greater than 1000V.
- Replace the fuse as soon as the indicator (FUSE) appears.
- Only replace the blown fuse with the proper rating as specified in this manual.
- Do not use the meter around explosive gas, vapor or dust.
- To reduce the risk of fire or electric shock do not expose this product to rain or moisture.











-
- **Do not attempt a current measurement when the open voltage is above the fuse protection rating. Suspected open voltage can be checked with voltage function.**
 - **Never attempt a voltage measurement with the test lead inserted into the A input terminal.**

CAUTION

This identifies conditions and actions that could DAMAGE the meter or equipment under test. To avoid possible damage, follow below guidelines.

- Disconnect the test leads from the test points before changing the position of the function rotary switch.
- Disconnect circuit power and discharge all high-voltage capacitors before testing resistance, continuity, diodes, or capacitance.
- Always use proper terminals, switch position, and range for measurements.
- Do not use the LoZ mode to measure voltages in circuits that could be damaged by this mode's low impedance.
- Replace the fuse as soon as the indicator (FUSE) appears.
- Never connect a source of voltage with the function rotary switch in resistance, diode, continuity, and capacitance position.
- Never set the meter in current function to measure the voltage of a power supply circuit in equipment that could result in damage the meter and the equipment under test.

Electrical Symbols

	Hazardous voltage		Risk of danger. Important information. See manual
	AC (Alternating Current)		
	DC (Direct Current)		Fuse
	Bluetooth		Double insulated
	Low battery		Conforms to European Union directives
	Earth ground		Do not discard this product or throw away
CAT III CAT IV	<p>IEC Overvoltage Category</p> <p>CAT III equipment is designed to protect against transients in equipment in fixed equipment installations, such as distribution panels, feeders and short branch circuits, and lighting systems in large buildings.</p> <p>CAT IV equipment is designed to protect against transients from the primary supply level, such as an electricity meter or an overhead or underground utility service.</p>		

Error Message

ProbE	Test probe alert. Displayed when the test probes are in the A or mA terminal and the selected rotary switch position does not correspond to the terminal being used.
FUSE	Fuse broke. Replace fuse as soon.
Er	Meter error. Have meter serviced.

The Meter Description

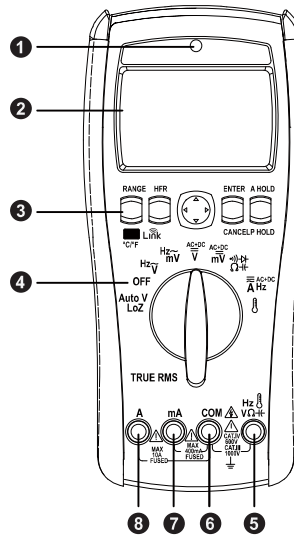

- Front panel illustration :
1. Auto backlight sense point
 2. 40,000 count dual display
 3. Push buttons
 4. Rotary switch
 5. Input terminal for voltage, frequency, resistance, continuity, diode, capacitance and temperature measurements.
 6. Return terminal for all measurements.
 7. Input terminal for 0 to 400mA current measurements.
 8. Input terminal for 0 to 10A current measurements.

Push Buttons

Function (Red)	Select measurement function.
RANGE	Select measurement range. Press > 1 sec to enter auto range mode.
HFR	Enable/Disable the High Frequency Reject mode in the AC measurements.
Link	Enable/Disable the Bluetooth mode.
A-HOLD	Enable/Disable the Auto-Hold mode.
P-HOLD	Enable the Peak-Hold mode in the AC or DC measurements. In this mode, press button to select Peak-Hold MAX or MIN. Press > 1 sec to disable the Peak-Hold mode.
ENTER	Enter menu function in pointer position.
CANCEL	Cancel current menu function.

Power On Options

When turn the power on, press the function button to execute the below options.

ENTER	Display the firmware version.
A-HOLD	Display all LCD segments.

Making Basic Measurements

WARNING

- When connecting the test leads to the DUT (Device Under Test), connect the common test lead before connecting the live lead. When removing the test leads, remove the test live lead before removing the common test lead.
- The following sections describe how to take measurements with the meter.

Making Basic Measurements

This meter have true rms readings, which are accurate for distorted sine waves and other waveforms (with no dc offset) such as square waves, triangle waves, and staircase waves.

The ranges of measuring voltage are 40mV, 400mV, 4V, 40V, 400V and 1000V. To select the mV range, turn the rotary switch to mV position.

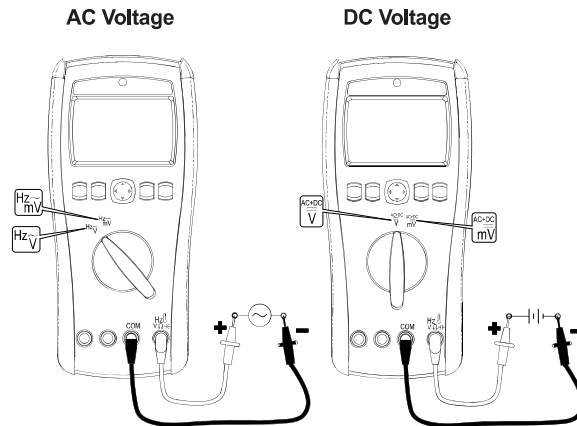

For best accuracy when measuring the DCmV, touch the probe tips together and read the DC offset. If necessary, you can use the relative (Δ) mode to automatically subtract this value.

Make dB measurement

The meter is capable of displaying voltage as a dB value, either relative to 1 milliwatt (dBm), a reference voltage of 1 volt (dB). A dBm measurement must use a reference impedance (600 Ω) to calculate a dB value based on 1 milliwatt. A dB measurement uses a 1 volt reference voltage to compare the present measurement against. Define as below :

$$dBm = 20 \log \left(\frac{V_{rms}}{\sqrt{600\Omega \times 1mW}} \right)$$

$$dB = 20 \log \left(\frac{V_{rms}}{1V} \right)$$

To use dB or dBm function, turn the rotary switch to ACV or ACmV position. Then move the blink cursor of menu to dB or dBm position, and press the ENTER button to enter function. Press the CANCEL button to exit function.

Measuring Voltage in LoZ Mode

CAUTION

Do not use the LoZ mode to measure voltages in circuits that could be damaged by this mode's low impedance.

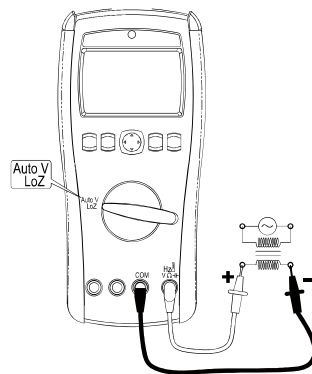

To eliminate ghost voltages, the meter's LoZ mode presents a low impedance across the leads to obtain a more accurate measurement. The ranges of measuring LoZ voltage are 400V and 1000V. In this mode, meter will automatic measure input signal which is AC or DC and determine range.

To use the LoZ mode, turn the rotary switch to LoZ position. turn the rotary switch to mV position.

Measuring AC and DC Current

WARNING

- Always use proper terminals, switch position, and range for measurements.
- To avoid possible electric shock or personal injury, never attempt an in-circuit current measurement where the open circuit potential to earth is greater than 1000V.
- Only replace the blown fuse with the proper rating as specified in this manual.

CAUTION

- Replace the fuse as soon as the indicator (FUSE) appears.

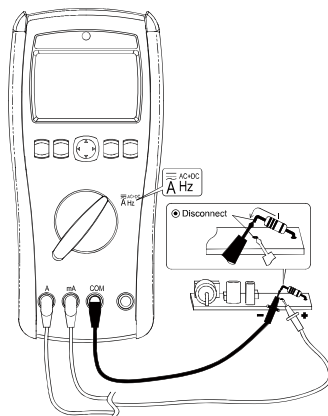

To measure current, you must break the circuit under test, then place the meter in series with the circuit.

The ranges of measuring current are 40mA, 400mA, 4A and 10A. AC current is displayed as an rms value. Insert the black lead into the COM terminal. For currents less than 400 mA, insert the red lead into the mA terminal. For currents above 400 mA, insert the red lead into the A terminal.

You can press the function (red) button to select current measurement function.

Measuring Frequency

The meter measures the frequency of a voltage or current signal by counting the number of times the signal crosses a threshold level each second.

This function only can be operated in AC voltage and current measurements. The ranges of measuring frequency are 400Hz, 4kHz, 40kHz and 100kHz.

If a reading shows as 0 Hz or is unstable, the input signal may be below or near the trigger level. The detail of frequency trigger level refer to the electrical specifications.

To use the frequency function, press function (red) button to select measurement function.

Make High Frequency Rejection Measurement

WARNING

Do not use the High Frequency Rejection (Low Pass Filter) option to verify the presence of hazardous voltages. Voltages greater than what is indicated may be present. First, make a voltage measurement without the filter to detect the possible presence of hazardous voltage. Then select the filter function.

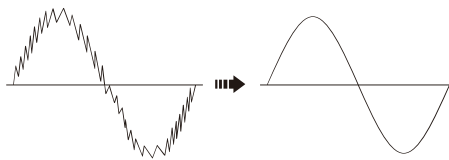

The High Frequency Rejection mode equip a low pass filter in the AC measurements. The cut-off frequency (-3dB point) of low pass filter is 800Hz. To use the HFR mode, press the HFR button to equip a low pass filter in the AC measurements.

Make Peak-Hold Measurement

The Peak-Hold mode records wave peak maximum and minimum input values. Response time of Peak-Hold is 10us.

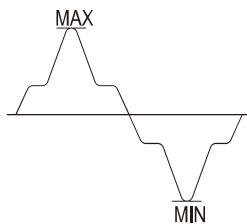

To use the Peak-Hold mode, press the P-HOLD button to enable the Peak-Hold mode in the AC or DC measurements. In this mode, press P-HOLD button to select peak MAX or MIN value. Press > 1 sec to disable the Peak-Hold mode.

For square wave, use the peak-hold mode in the DC measurements.

Make AC+DC Measurement

When input signal is ac and dc combinations: AC over DC or DC over AC, the meter is capable of displaying one AC+DC (rms) value combined. Define as below :

$$(AC + DC) V_{rms} = \sqrt{ACV^2 + DCV^2}$$

$$(AC + DC) A_{rms} = \sqrt{ACA^2 + DCA^2}$$

To use the AC+DC function, turn rotary switch stop in DCV, DCmV or A position, then press function (red) button to select measurement function,

Measuring Resistance

CAUTION

To avoid possible damage to the meter or to the equipment under test, disconnect circuit power and discharge all high voltage capacitors before measuring resistance.

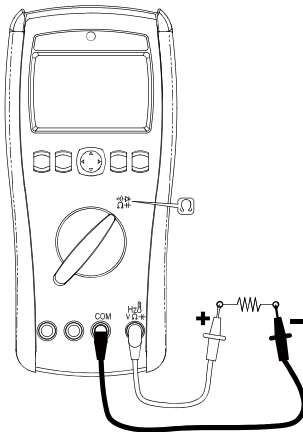

The ranges of measuring resistance are 400Ω, 4kΩ, 40kΩ, 400kΩ, 4MΩ, and 40MΩ.

The test leads may add 0.1Ω to 0.2Ω of error to resistance measurements. To test the leads, touch the probe tips together and read the resistance of the leads. For best accuracy, you can use the relative (Δ) mode to automatically subtract this value.

High-resistance (>10MΩ) readings are susceptible to electrical noise. To smooth out most noisy readings, enter the MAX/MIN recording mode; then step to the average (AVG) reading.

Continuity Check

CAUTION

To avoid possible damage to the meter or to the equipment under test, disconnect circuit power and discharge all high voltage capacitors before testing continuity.

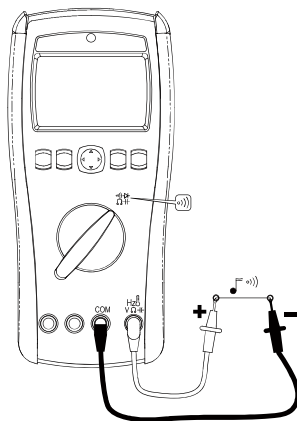

The continuity check features a buzzer that sounds as long as a circuit is complete. The buzzer allows you to quick continuity checks without watching the display.

When measuring resistance is less than threshold, the buzzer sounds. You can setup the threshold in setup mode. The continuity threshold is default 30Ω.

To use continuity check, turn the rotary switch to resistance position, then press the function (red) button to select measuring mode.

Testing Diodes

⚠ CAUTION

To avoid possible damage to the meter or to the equipment under test, disconnect circuit power and discharge all highvoltage capacitors before testing diodes.

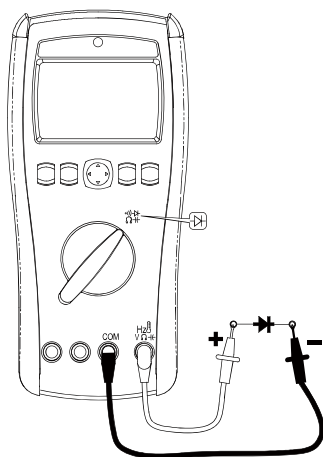

Use the diode function to check diodes, transistors, silicon controlled rectifiers (SCRs), and other semiconductor devices. This function tests a semiconductor junction by sending a current through the junction, then measuring the junction's voltage drop. A good silicon junction drops between 0.5V and 0.8V.

For forward-bias readings on any semiconductor component, place the red test lead on the component's positive terminal and place the black lead on the component's negative terminal. In a circuit, a good diode should still produce a forward-bias reading of 0.5V to 0.8V.

To use diode function, turn the rotary switch to resistance position, then press the function (red) button to select measuring mode.

Measuring Capacitance

⚠ CAUTION

To avoid possible damage to the meter or to the equipment under test, disconnect circuit power and discharge all highvoltage capacitors before measuring capacitance. Use the dc voltage function to confirm that the capacitor is discharged.

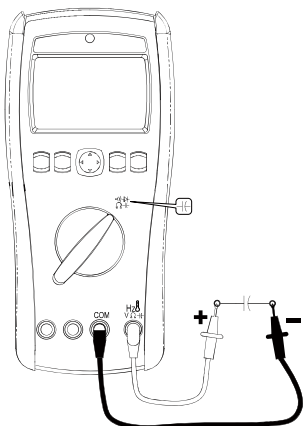

The ranges of measuring capacitance are 40nF, 400nF, 4uF, 40uF, 400uF, 4mF and 40mF.

To improve the accuracy of measurements less than 1000nF, you can use the relative (Δ) mode to subtract the residual capacitance of the leads.

To use capacitance measurement, turn the rotary switch to resistance position, then press the function (red) button to select measuring mode.

Measuring Temperature

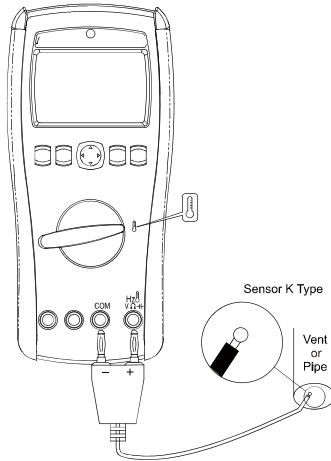

The meter measures the temperature of a K-Type thermocouple. You can press the function (red) button to choose degrees Celsius (°C) or degrees Fahrenheit (°F).

Display ranges are -200°C to +1200°C and -328°F to +2192°F. Readings outside of these ranges show "OL" on the display. When there is no thermocouple connected, the display also shows "OL".

To use temperature measurement, turn the rotary switch to temperature position, then press the function (red) button to select measuring mode.

Auto-Hold

When measuring, you can press the A-HOLD button to start the Auto-Hold mode. In this mode, the meter holds reading and shows it on the secondary display.

If the difference between new reading and hold reading is bigger than 5d (3¼-digit mode), and new reading is also stable, then meter automatically holds a new reading on the secondary display.

When reading is smaller than Auto-Hold limit, or reading is OL, the Auto-Hold mode is not working.

Function	Limit
V, A, LoZ, Hz, Cap	1% of range
Others	No limit

To exit Auto-Hold mode, press the A-HOLD button again. If you don't want to use the Auto-Hold mode, you can disable it in the setup mode. When Auto-Hold mode is disable, the hold mode is not update any new reading.

Maximum / Minimum Record

When measuring, you can record the maximum, minimum and average value of reading.

To use maximum / minimum record mode, move the blink cursor of menu to MAX, MIN or AVG position, and press the ENTER button to enter mode. In this mode, the meter records each data to compare the maximum and minimum value. Also, meter calculate the average of reading.

You can move the blink cursor of menu to MAX, MIN or AVG position, and press the ENTER button to select result on the secondary display.

When maximum / minimum record mode running, if you wants to pause recording, press the A-HOLD button. Press again to continue.

To exit maximum / minimum record mode, press the CANCEL button.

Relative Δ

When measuring, you can use the relative (Δ) mode to subtract the offset.

To use relative (Δ) mode, move the blink cursor of menu to Δ position, and press the ENTER button to enter mode. In this mode, meter records the presently reading as reference and shows it on the secondary display. The relative (Δ) mode subtract reference from each reading, and shows result on the main display.

In relative (Δ) mode, the minimum range is relative (Δ) range. For example: The ranges of measuring resistance are 400Ω, 4kΩ, 40kΩ, 400kΩ, 4MΩ, and 40MΩ. If you use the relative (Δ) mode in 4kΩ range, then the minimum range is the 4kΩ range. You can use range is 4kΩ to 40MΩ, cannot change to 400Ω.

To exit relative (Δ) mode, press the CANCEL button.

Relative %

When measuring, you can use the relative (%) mode to calculate the relative percent value. The relative percent value is define as below:

$$\text{Relative \%} = [(\text{Reading} - \text{Ref}) \div \text{Ref}] \times 100.0\%$$

To use relative (%) mode, move the blink cursor of menu to % position, and press the ENTER button to enter mode. In this mode, meter records the presently reading as reference and shows it on the secondary display. The relative (%) mode calculate the relative percent value from each reading, and shows result on the main display.

To exit relative (%) mode, press the CANCEL button.

Memory Save / Load

When measuring, you can save the reading to memory and load it from memory. The meter can store maximum 1000 data in memory. The recorded data amount shows on the secondary display.

To use memory save / load mode, move the blink cursor of menu to MEM position, and press the ENTER button to enter mode. In this mode, you can operate the below options:

Memory Options	
A-SAVE	You can operate the Auto-Save mode to automati-cally save new reading. When you use the probes to measure a new reading, the meter will automati-cally save it. In some case, the Auto-Save mode will not work. For example, the reading is smaller than the limit (refer Auto-Hold), or the reading is OL. Press ENTER button to start Auto-Save mode, press CANCEL button to exit.
SAVE	Press ENTER button to save a new reading to memory.
LOAD	You can press the ENTER button to review data from memory. Press UP or DOWN button to select data. Press the CANCEL button to return.
CLR	Press ENTER button to clear all data from memory.
MAX	Press ENTER button to review the maximum data from memory.
MIN	Press ENTER button to review the minimum data from memory.

To exit memory save / load mode, press the CANCEL button.

Data Logger

You can record a lot of reading to memory in a long time, then analyze and plot graph. The meter can store maximum 40,000 data in memory. The recorded data amount shows on the secondary display,

The record rate can be set from 1 sec and 600 sec. The error of timer is less than 3 seconds per hour.

To use data logger, move the blink cursor of menu to LOG position, and press the ENTER button to enter mode. In this mode, you can operate the below options :

Data Logger Options	
SAVE	Press ENTER button to start data logger. The logger automatically records at regular intervals. You can press ENTER button to pause data logger, press again to continue. To stop data logger, press CANCEL button to return.
LOAD	You can press the ENTER button to review data from memory. Press UP or DOWN button to select data. Press the CANCEL button to return.
CLR	Press ENTER button to clear all data from memory.
RATE	You can setup the record rate of logger. Press UP or DOWN button to select rate. Press the CANCEL button to return.
MAX	Press ENTER button to review the maximum data from memory.
MIN	Press ENTER button to review the minimum data from memory.

To exit data logger, press the CANCEL button.

Auto Power Off

If you don't operate the rotary switch or buttons for a specified time, the meter will turn off automatically to save the power of batteries. The default APO timer is 10 minutes. In setup mode, you can change the APO timer.

Backlight

The backlight is automatically turned on at dark environment. The backlight mode is default auto. In setup mode, you can set the backlight mode.

Buzzer

The meter equip a 2kHz tone buzzer. Valid button press: Beep once. And invalid button press: Beep twice. In setup mode, you can turn on or off the buzzer. But the buzzer in continuity check cannot be turn off.

Display Resolution

This meter have two display resolution: normal resolution (3¼-digit mode) and high resolution (4¼-digit mode). The normal resolution is set to default. You can setup the resolution in setup mode.

Setup

To use meter setup mode, move the blink cursor of menu to SETUP position, and press the ENTER button to enter function. Press the UP or DOWN button to select item; press the LEFT or RIGHT to select options. When you complete setup, press the CANCEL button to exit setup mode.

Setup Options	
APO	APO timer: 1min to 30min, or OFF
b.Lit	Backlight mode: Auto, ON or OFF
bEEP	Buzzer ON or OFF
A.Hold	Auto-Hold mode ON or OFF
Cntin	Continuity threshold: 10 Ω to 50 Ω
diGit	Display digit: Lo or Hi
TEMP	Temperature default unit: $^{\circ}$ C or $^{\circ}$ F
RESET	Press ENTER to reset all setup options.

IR Communications

You can use the IR (infrared) communication link and WinDMM software to transfer the real-time data of meter to PC. In addition, the meter allows the user to log to internal memory and connect to the computer later for download.

For detailed information, refer to the WinDMM Installation Guide or the on-line help.



The meter uses Wireless low energy (BLE) V4.0 wireless technology to transfer the real-time reading and the stored data.

The open-air communication range is up to 10m.

Download "KPS Link" App via the following QR Code. Turn on Bluetooth function of the meter and open "KPS Link" to connect the DMM. The Bluetooth icon of the meter will freeze on LCD after the connection establishes successfully.

Maintenance

Verify the meter's operation by measuring a known voltage. If in doubt, have the meter serviced. Do not attempt to repair this meter. It contains no user serviceable parts. Repair or servicing should only be performed by qualified personnel. To maintain best accuracy, calibrate meter once a year.

Cleaning

Periodically wipe the case with a dry cloth and detergent.
Do not use abrasives or solvents.

Replace Batteries & Fuse



WARNING

- Remove test lead from meter before opening the battery door or meter case.
- Replace the fuse as soon as the indicator (FUSE) appears.
- Only replace the blown fuse with the proper rating as specified in this manual.

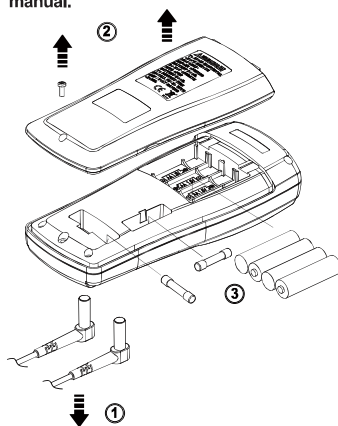

Battery Type :
4 x 1.5V IEC LR6 or size AA

Fuse1 Type :
440mA, 1000V IR 10kA Fuse

Fuse2 Type :
11A, 1000V IR 20kA Fuse

When the battery low indication shows on the display, replace the batteries soon. To save the power of batteries, you can disable the backlight and buzzer in setup mode.

General Specifications

MAX Voltage between any Terminal and Earth Ground :
1000Vrms

Fuse Protection for mA inputs : 440mA, 1000V IR 10kA Fuse

Fuse Protection for A inputs : 11A, 1000V IR 20kA Fuse

Display : 4,000/40,000 counts, over range to 110%.

Over Range Indication : OL

Measuring Rate : 10 samples per second

Power Requirements : 4 x 1.5V IEC LR6 or size AA

Battery Life : 50 hours typical with alkaline (with backlight off).

Operating Ambient : -10°C to 30°C (< 85% RH),
30°C to 40°C (< 75% RH),
40°C to 50°C (< 45% RH)

Storage Temperature :

-20°C to 60°C, 0% RH to 80% RH (batteries not fitted)

Temperature Coefficient :

0.1 x (Specified Accuracy) / °C, < 18°C or > 28°C

Operating Altitude : 6561.7ft (2000m)

Calibration Cycle : 1 time per year.

Weight : 465g including battery.

Dimensions (H x W x L) : 52 x 83 x 188 (mm) with holster.

RF Communications : 2.4 GHz ISM Band, open air 10m

Safety : Complies with EN 61010-1

CAT IV 600V, CAT III 1000V

CAT	Application Field
I	The circuits not connected to mains.
II	The circuits directly connected to Low-voltage installation.
III	The building installation.
IV	The source of the Low-voltage installation.

EMC : EN 61326-1

Pollution Degree : 2

Shock Vibration : Per MIL-PRF-28800F for a Class 2 instrument

Drop Protection : 5ft (1.5m)

Indoor Use

Electrical Specifications

- Accuracy is \pm (% of reading + number of digits) at 18°C to 28°C (< 80% RH)
- For specifications in the 4 $\frac{1}{2}$ -digit mode, multiply the number of digits by 10.
- For the best measurements, with relative (Δ) mode to compensate for offsets.

Voltage

Function	Range	Accuracy
AC	40.00mV [1]	Sine Wave: 0.5%+2d for 40Hz to 70Hz [3] 1.5%+4d for 70Hz to 1kHz [3] 3.0%+4d for 1kHz to 5kHz [3] 5.0%+20d for 5kHz to 100kHz [4][5]
	400.0mV [1]	
	4.000V	
	40.00V	
	400.0V [1]	
DC	1000V [2]	0.03%+3d
	40.00mV	
	400.0mV	
	4.000V	
	40.00V	
AutoV LoZ	400.0V	2.0%+4d for ACV 40Hz to 1kHz 2.0%+4d for DCV
	1000V	

[1] The bandwidth is 40Hz to 5kHz
 [2] The bandwidth is 40Hz to 1kHz
 [3] Below 10% of range, add 2d to accuracy.
 [4] Below 10% of range, add 10d to accuracy. < 50kHz.
 [5] Below 10% of range, add 20d to accuracy. > 50kHz.

Input Impedance : 10M Ω , < 100pF

LoZ Input Impedance : 3k Ω

Bandwidth : 40Hz to 100kHz

Minimum Resolution : 10 μ V

CMRR / NMRR (Common / Normal Mode Rejection Ratio) :

VAC : CMRR > 60dB at DC, 50Hz / 60Hz

VDC : CMRR > 100dB at DC, 50Hz / 60Hz

NMRR > 50dB at DC, 50Hz / 60Hz

Current

Function	Range	Accuracy
AC	40.00mA	Sine Wave: 0.8%+2d for 40Hz to 70Hz [3] 2.0%+4d for 70Hz to 1kHz [3] 2.0%+4d for 1kHz to 10kHz [4]
	400.0mA	
	4.000A [1]	
	10.00A [1][2]	
DC	40.00mA	0.2%+1d
	400.0mA	
	4.000A	0.2%+2d
10.00A [2]		
[1] The bandwidth is 40Hz to 1kHz [2] When > 10A, accuracy is unspecified and maximum measuring time is 30 sec. [3] Below 10% of range, add 2d to accuracy. [4] Below 10% of range, add 10d to accuracy.		

Input Impedance : < 2Ω at mA inputs, < 0.1Ω at A inputs.

Bandwidth : 40Hz to 10kHz

Minimum Resolution : 10uA

Maximum Measuring Time :

1 minutes at A inputs, 10 minutes at mA inputs.

Rest time is 20 minutes minimum.

AC and DC Additional Specifications

Function	Range	Accuracy
AC+DC	Same as V & A	AC accuracy + 1.0%]
HFR		AC accuracy + 1.0% for 40Hz to 400Hz
Peak-Hold		3.0%+200d for 40Hz to 1kHz [1]
[1] For square wave, the accuracy is unspecified.		

The Cut-Off Frequency of HFR: 800Hz (-3dB point)

Attenuation Characteristic of HFR: Approx. -24dB

AC Conversion Type:

The AC conversion type is ac-coupled, true rms responding, calibrated to the sine wave input. For non-sine wave add the following Crest Factor corrections:

For Crest Factor of 1.4 to 2.0, add 1.0% to AC accuracy.

For Crest Factor of 2.0 to 2.5, add 2.5% to AC accuracy.

For Crest Factor of 2.5 to 3.0, add 4.0% to AC accuracy.

Frequency Counter

Range	Resolution	Accuracy
400.0Hz	0.1Hz	1d (3¼-digit mode) 5d (4¾-digit mode)
4.000kHz	1Hz	
40.00kHz	10Hz	
100.0kHz	100Hz	

Minimum Sensed Frequency : 5Hz

Frequency Counter Sensitivity

Function	Range	Sensitivity (Peak to Peak)	
		5 to 10k Hz	10k to 100k Hz
mV	40.00mV	10mV	10mV
	400.0mV	40mV	100mV
V	4.000V	0.4V	1V
	40.00V	4V	10V
	400.0V	40V	Unspecified
	1000V	400V	
mA	40.00mA	10mA	Unspecified
	400.mA	40mA	
A	4.000A	1A	
	10.00A	4A	

Resistance

Range	Resolution	Accuracy
400.0Ω	0.1Ω	0.2%+2d
4.000kΩ	1Ω	0.2%+1d
40.00kΩ	10Ω	
400.0kΩ	100Ω	
4.000MΩ	1kΩ	1.0%+1d
40.00MΩ	10kΩ	2.0%+20d

Maximum Open Circuit Voltage : Approx. 2.5V

Maximum Short Test Current : Approx. 0.1mA

Continuity Check

Range	Resolution	Accuracy
400.0Ω	0.1Ω	0.2%+2d

Maximum Open Circuit Voltage : Approx. 2.5V

Maximum Short Test Current : Approx. 0.1mA

Continuity Threshold : Adjustable 10 to 50 Ω, default 30Ω.

Continuity Indicator : 2kHz Tone Buzzer

Testing Diodes

Range	Resolution	Accuracy
2.000V	1mV	1.5%+2d

Maximum Open Circuit Voltage : Approx. 2.5V

Maximum Short Test Current : Approx. 1mA

Frequency Counter Sensitivity

Range	Resolution	Measuring Time	Accuracy
40.00nF	10pF	1 sec	0.9%+20d
400.0nF	100pF	1 sec	0.9%+10d
4.000uF	1nF	1 sec	0.9%+2d
40.00uF	10nF	1 sec	
400.0uF	100nF	1 sec	
4.000mF	1uF	4 sec	0.9%+10d
40.00mF	10uF	8 sec	0.9%+20d

Temperature

Range	Resolution	Accuracy
-200°C to +1200°C	0.1°C	1.0%+30d
-328°F to +2192°F	0.1°F	1.0%+54d











[1] Does not include error of the thermocouple probe.
 [2] Accuracy specification assumes ambient temperature stable to $\pm 1^\circ\text{C}$. For ambient temperature changes of $\pm 2^\circ\text{C}$, rated accuracy applies after 1 hour.



DIREKTRONIK

Direktronik AB tel. 08-52 400 700 www.direktronik.se

Símbolos eléctricos

	Tensión peligrosa		Riesgo de peligro. Información importante. Ver manual
	CA (corriente alterna)		
	CC (corriente continua)		Fusible
	Bluetooth		Doble aislamiento
	Pila baja		Se ajusta a las directivas de la Unión Europea
	Conexión a tierra		No tire a la basura este producto
CAT III CAT IV	<p>Categoría de sobretensión del IEC</p> <p>Los equipos CAT III están diseñado para protegerse contra transitorios en equipos en instalaciones fijas, como paneles de distribución, alimentadores y circuitos derivado de corto, y sistemas de iluminación en edificios grandes.</p> <p>Los equipos CAT IV están diseñado para protegerse contra los transitorios del nivel primario de alimentación, como un contador de electricidad o un instalaciones públicas subterráneas o aéreas.</p>		

Mensaje de error

Sonda	Alerta de sonda de prueba. Se muestra cuando las sondas de prueba se encuentran en el borne A o mA y la posición del dial seleccionada no corresponde al borne que se está utilizando.
FUSIBLE	Fusible quemado. Reemplace el fusible tan pronto como se posible.
Er	Error del medidor. Repare el medidor.